

INTEGRATED REALTIME SIMULATION OF VOLTAGE REGULATION ALGORITHMS IN A MICROGRID WITH DERS: LEVERAGING THE DERCONNECT TESTBED

Sayed Abdullah Sadat^a, Benjamin Hwang^a, Kohei Murakami^a,
Jan Kleissl^a, Jorge Cortes^a, and Adil Khurram^a

¹Department of Mechanical & Aerospace Engineering, University of California, San Diego
{sasadat, bdhwang, k1murakami, jkleissl, cortes, akhurram}@ucsd.edu

ABSTRACT

This paper studies real-time hybrid co-simulation of voltage regulation in the University of California San Diego (UCSD) microgrid. We integrate a hardware inverter controller with two subsystems simultaneously simulated in RTDS and Typhoon HIL platforms within a single framework. Using real-time load metering data, we emulate realistic conditions of the UCSD microgrid. To enhance voltage regulation, we employ centralized and distributed algorithms based on a second-order conic relaxation of the nonlinear voltage regulation formulation. These algorithms are tested in a hybrid physical and simulation environment using the physical assets of the distributed energy resources connect (DERConnect) testbed under various real-time loading scenarios, providing a realistic testing ground. Our results demonstrate the effectiveness and suitability of these algorithms for distributed voltage regulation in real-world microgrid scenarios. This research advances practical simulation of voltage control strategies in microgrids, with potential applications in enhancing the stability, scalability, and efficiency of power distribution systems.

Keywords: integrated co-simulation, voltage regulation, DERConnect testbed, distributed energy resources

1 INTRODUCTION

The entrance of Distributed Energy Resources (DERs) in microgrids has revolutionized power systems, and continues to attract multi-billion dollar investments in smart grid technology through projects like [1]. As power demand increases, renewable generation through DERs is imperative to a clean energy economy, as stated by the outlook in the work of [2]. However, as described by the work of [3], the conventional power system infrastructure was not designed for distributed generation and the high penetration of DERs has introduced grid resiliency challenges. In particular, the study from [4] shows that distributed generation causes more voltage fluctuations compared to conventional generation methods. Additionally, the uncertain nature of DERs calls for fast voltage control devices and methods, as shown in the work from [5]. These issues drive research into methods for controlling voltage using various devices, as summarized in the review of [6]. The field of distributed methods for controlling ancillary services has gained popularity due to its computational scalability, with the work of [7, 8] as examples.

Conducting thorough tests for novel control strategies is essential for their safe deployment on actual systems. Challenges such as fast dynamics, uncertain loads, and unpredictable renewable generation underscore the need for advancements in testing infrastructure. The study in [9] highlights the challenge of achieving high-fidelity real-time simulation of power networks for testing smart grid technologies, particularly due to the rapid dynamics of power electronic devices. Robust testing requires validation under various system

conditions, including different network topologies, loading profiles, and communication systems. This need has led to the developments, such as the work in [10], of modular co-simulation testbeds that enable different simulators to interact. This interaction offers several advantages, such as scaling up simulation size with additional simulators to simulate more components, and running simulators at different resolutions for higher fidelity simulations of processes with faster dynamics. However, these advantages come with synchronization challenges that require additional communication. In the work of [10], the authors integrate simulators by assuming steady-state conditions between each time step, however this approach ignores transients. Another challenge in creating a testing framework which simulates multiple systems simultaneously is the integration of data. The project in [11] demonstrated a method of integrating data from several sources into a cohesive simulation framework, while work in [12] used OPNET to help read live data from network hardware. The work in [13] demonstrated that integrating various simulators can enable complex tasks such as actuator and control hardware in the loop testing. However, their framework focuses on thermal systems, whereas our work is centered on power systems. The work in [14] shows the need for co-simulation to allow simulations of different environments to share resources and information. They provide a setup for such simulation integration and apply it to a test that combines the power and gas grids. To test the real-time efficacy, early works, such as [15], have used real-time simulation in many different testing applications, including synchronous motors. The work in [16] demonstrated a compensator-based, distributed generation controller was tested in a small, three-bus microgrid, which was simulated on a Real-Time Digital Simulator (RTDS) [17]. Other than testing control algorithms in simulations, real-time simulation is also commonly used for testing power hardware. In [18], RTDS was used for power hardware-in-the-loop (HIL) testing of a PV inverter. Voltage source inverter controls in stationary and synchronous frames were tested with a control HIL set up using a Typhoon HIL [19] simulator in [20]. Recently, the work in [21] tested an optimization-based frequency controller on a real-time simulated thermal power plant system.

To provide a modular platform for real-time co-simulation of power systems, in addition to integrated testing of novel control algorithms, we introduce the UCSD's DERConnect testbed, an advanced National Science Foundation (NSF) sponsored mid-scale research infrastructure testing facility that is under construction and will open to users in 2025 [22, 23]. The platform allows integrated real-time testing and simulation of control hardware and software on a configurable simulated grid. The flexible testbed also allows easy integration of in-house co-simulation to emulate external power hardware as well as the integration of real power data drawn from UCSD campus resources. We exhibit some of the capabilities of the DERConnect testbed in a voltage control application. To validate the efficacy of a voltage regulation algorithm, we conduct real-time simulations of the UCSD microgrid using RTDS. Furthermore, we simultaneously emulate the dynamic behavior of an inverter through Typhoon HIL, controlled by a real inverter controller. By incorporating actual operational data such as real-time metering, we bridge the gap between simulation models and real-world microgrid dynamics, ensuring the relevance and applicability of our proposed voltage regulation approach. The main contributions of this paper are:

1. Application of an integrated real-time simulation, or hybrid co-simulation, of the DER-integrated UCSD microgrid in conjunction with an inverter controller, utilizing real-time load metering data.
2. Custom development of a DER management system and communication setup to enable the utilization of various physical assets from the DERConnect testbed within the proposed hybrid co-simulation framework.
3. Investigation of centralized and distributed voltage regulation algorithms in the DER-connected reduced model of the UCSD microgrid within the DERConnect testbed under realistic conditions across various scenarios.

The subsequent sections of this paper are organized as follows. Section 2 delineates the hybrid co-simulation framework, elaborating on DERConnect, DERMS, and integrated real-time simulation, implemented as a

hybrid co-simulation framework, for emulating the UCSD microgrid. Progressing to Section 3, we provide a detailed account of the case study scenarios, voltage regulation algorithms, and present the results. The paper concludes in Section 4 with a summary of findings and their implications.

2 HYBRID CO-SIMULATION FRAMEWORK

The integration of physical hardware with virtual simulations in a hybrid framework is essential for engineering applications, combining their strengths to significantly improve testing fidelity. This approach merges physical components with simulation models, enabling more effective design validation and issue discovery not evident in purely simulated environments. Importantly, this integration is cost-effective compared to traditional methods involving expensive and risky physical prototypes. The hybrid approach also offers unparalleled flexibility in testing scenarios, allowing engineers to model diverse conditions and parameters that would be challenging or costly to replicate physically. Safety is another critical benefit, especially in industries like power systems, automotive, and aerospace, where testing potentially hazardous scenarios in a controlled environment ensures the safety and integrity of designs. Additionally, the hybrid hardware and simulations approach is invaluable for optimization studies, enabling engineers to refine designs for optimal performance and efficiency, leading to better overall outcomes.

In this paper, we present a novel hybrid simulation framework for studying real-time voltage regulation using centralized and distributed algorithms. A key advantage of this framework is its ability to conduct real-time testing without risking damage to grid components or disrupting power supply to the campus. To support this framework, we utilize physical assets from the DERConnect testbed, developing a custom DER management system (DERMS) and establishing communication between assets. The UCSD microgrid, along with batteries, inverters, and photovoltaic (PV) systems, is modeled in RTDS along with a battery coupled with its inverter simulated in Typhoon HIL. We use an EPC Power inverter model developed by manufacturers and interface it with digital and analog I/O to the actual EPC Power inverter controller. This interface enables testing of the EPC Power inverter with the UCSD microgrid model with minimal effort. The synchronized co-simulation interface between RTDS and Typhoon HIL enhances computational capacity by combining their capabilities, while also simplifying the integration process compared to traditional wired methods. We term this integrated approach, which combines simulators and physical devices through DERMS, as a hybrid co-simulation framework.

The hardware components used include building meters, EPC Power inverter controller, edge controllers distributed across the microgrid, and communication infrastructure facilitating data exchange. Simulation components consist of the microgrid, battery energy storage systems (BESS), PV arrays, and inverters. The framework utilizes one edge controller for the centralized algorithm and six edge controllers for the distributed algorithm. Each edge controller regulates voltage in a designated group of buses within the UCSD microgrid as shown in Figure 1. In the distributed algorithm, these controllers communicate solely with neighboring controllers to collaboratively ensure optimal voltage regulation network-wide, preserving the inherent potential for improved scalability of the distributed algorithm.

2.1 Distributed Energy Resources Connect (DERConnect)

In pursuit of advancing research and testing of DERs, the University of California, San Diego (UCSD) is establishing DERConnect. This remotely accessible mid-scale research infrastructure testbed is funded by the National Science Foundation (NSF) and is envisioned as a cutting-edge facility encompassing a diverse array of DERs to serve as a platform for research and testing purposes.

Given the crucial role of DERs in modern electrical grids, it is important to test their response to various grid events, including loss of generation, under/over voltage, and frequency fluctuations. Accurate replication

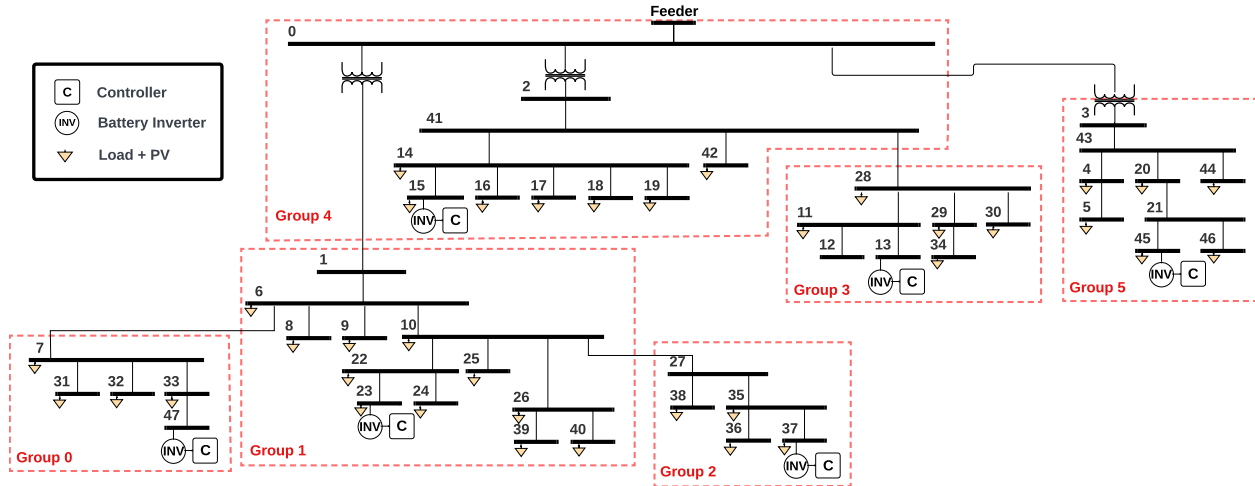

Figure 1: Block diagram of grouping of the UCSD microgrid for the distributed voltage regulation algorithm.

of these events is essential to ascertain DER conformity with standards such as IEEE-1547. DERConnect will provide the means to create, execute, and evaluate such tests. Scheduled to open to researchers nationwide in 2025, DERConnect consists of physical DERs, communication infrastructure, computing resources, real-time simulators, and a DER management system (DERMS). However, since the testbed is not yet commissioned, components such as DERMS and the communication setup are not fully developed yet. To conduct our study, we develop a custom DERMS and set up our own communication between the physical components of DERConnect. Our custom DERMS and communication setup closely mimic the planned DERConnect components, ensuring the validity and relevance of our study’s findings.

2.2 Distributed Energy Resources Management System (DERMS)

DERMS serves as the backbone of our hybrid co-simulation framework, facilitating the connection of different hardware and simulated components. Our custom DER management system, developed for this study, integrates centralized and distributed control algorithms by allocating and deploying algorithms to all edge controllers as shown in Figure 2. Additionally, the DERMS server hosts MySQL databases, simplifying the collection of data from various components in our test framework. DERMS manages communication, data storage, algorithmic computation, and DER actuation, through individual computational resources known as DER nodes. This provides an all-in-one platform for testing two voltage regulation algorithms. In addition to DER nodes, the framework includes an aggregator for DER nodes, which facilitates communication between nodes and the DERMS. The aggregator for DER nodes serves as a communication hub for subsets of DER nodes, routing data and communication signals in the network of DER nodes.

DER nodes and aggregator implementations are deployed as Docker containers that run on edge computers. A DER node container handles communication between other DER node containers and calculates algorithm outputs. Communication between nodes is achieved through asynchronous TCP data streams. A DER node receives messages from the aggregator and stores them in a queue for processing in an order that preserves synchronous operation of the algorithm and simulation. This synchronization is based on the algorithm step, ensuring the preservation of message order. The aggregator container collects information from various sources in the DERMS network and distributes it to the appropriate locations. The aggregator’s communication with DER nodes occurs through TCP streams. Additionally, the aggregator integration includes communication with real UCSD building meters, RTDS, Typhoon HIL, and a physical EPC Power controller, each through Modbus. The aggregator is also responsible for recording algorithm and measure-

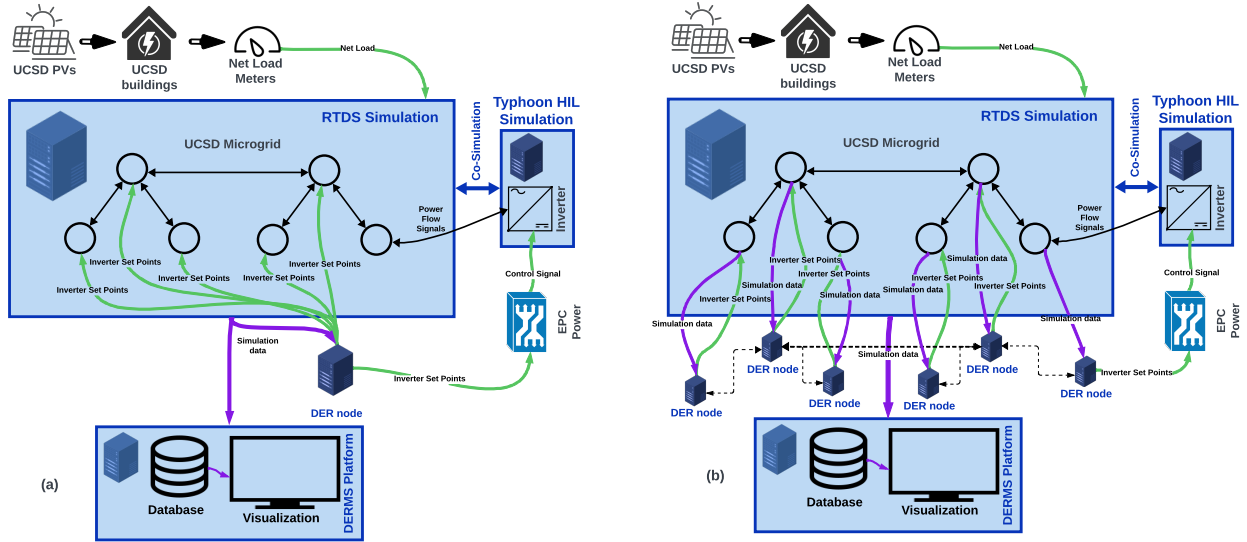

Figure 2: Schematic diagram of the DERConnect testbed components to simulate UCSD microgrid operation for a) centralized voltage regulation and b) distributed voltage regulation. Purple and green arrows indicate data and communication transfer facilitated by DERMS. Execution of the simulation involves three parallel processes. The first includes set point calculation which depends on reading from UCSD PVs and meters then sending those set points to RTDS and EPC Power. The second and third are the two simulators, RTDS and Typhoon HIL, running in parallel.

ment data from UCSD meters. This data is stored on the database located at the DERMS server. This communication pathway is facilitated through an API implementation in the DERMS.

To facilitate future applications, a full-scale production version of DERMS is under development. It will be available with the DERConnect testbed commissioned in 2025. The production DERMS will offer flexibility, allowing users to configure the testbed based on their desired simulation framework. It is designed as resource management software to accommodate the testing of distributed control algorithms on a cyber-physical system that includes 5,000 real DERs and up to 1 million simulated DERs (when incorporating co-simulation and real-time grid simulation). The distributed control implemented by the DERMS will enable parallel execution of tasks with communication between tasks facilitated through various protocols. Key functions of the DERMS include co-simulation, data management, and user interface support, aimed at fostering interaction with DERs located within DERConnect. Some examples of DERs that available as part of DERConnect include real-world campus DERs, dedicated DERConnect DERs, and RTS DERs. The architecture layout is shown in Figure 3. The objective of the DERMS is to ensure seamless access and operation of the DERConnect testbed, catering to both academic and industrial users.

2.3 Integrated Real-time Simulation

To integrate the RTDS and Typhoon HIL simulators into a unified real-time simulation environment, we develop a communication-based interface using Modbus communications, a protocol that is supported by both simulators. Both real-time simulators are equipped with Field Programmable Gate Arrays (FPGAs) where the architecture is specialized to solve nonlinear differential equations of power grid dynamics and observe its electromagnetic transient (EMT) states in real time. For example, measurements streamed from the simulation under a disturbance appear to measurements from probes in the actual power grid under the disturbance. As previously mentioned, the RTDS simulates the UCSD microgrid as an AC power grid,

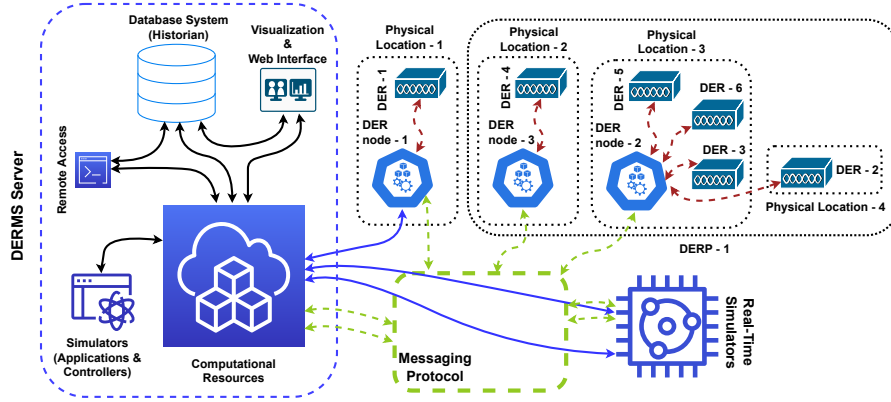

Figure 3: DERMS architecture: Layout of the main components and communication protocols.

including transformers, power cables, and loads, alongside BESSs and PV systems. The power cables are modeled with series resistances and inductances, while the load, BESS, and PV system are modeled with controllable active and reactive power sources to simplify the microgrid model. The Typhoon HIL simulates only a single EPC power inverter, consisting of a three-phase, two-level inverter, LCL filter, isolation transformer, and DC voltage source.

To connect the two independent simulations at bus 13 in the UCSD microgrid model, shown in Figure 1, equivalent voltage and current sources are added in each simulation to represent each other’s circuits. Power flows on the bus are controlled to match by exchanging measurements through communications. As shown in Figure 4, a controllable current source is added to the bus on the simulated microgrid model in the RTDS. The EPC Power inverter model is connected to a controllable voltage source through a transformer, with the connection voltage adjusted in the Typhoon HIL. The EPC Power controller is attached to the inverter model through analog and digital I/O.

In the EMT simulation, voltage and current are simulated as instantaneous quantities with respect to time. While the instantaneous measurements of voltage and current should be exchanged between the two simulators to match electrical quantities in sinusoidal wave forms, the exchange frequency must be at least as large as the power system frequency (e.g., 60 Hz in the US). Due to limitations of the simulator communication features, phasor quantities—where the AC quantities are described as a set of magnitude and phase angle—are used in our work, and the two simulations are integrated in terms of power flows. While the integrated simulation may not yield accurate EMT simulations, the simulated phasor quantities are valid for slower time-scale phenomena such as voltage regulation.

To match the active and reactive power flow, the Typhoon HIL simulator uses the magnitude of the voltage phasor measured at bus 13 in the RTDS simulator as the voltage source input. The RTDS simulator uses the magnitude and angle of the current phasor measured at the voltage source in the Typhoon HIL simulator as the current source input. Both simulators exchange these measurements using Modbus communication every 0.05 seconds. The simulation time steps are 50 μ s on RTDS and 2 μ s on Typhoon HIL.

3 CASE STUDY

We apply our hybrid, real-time, co-simulation setup to two control algorithms for voltage regulation in a distribution grid. This section will briefly describe the problem and the details of the simulation results.

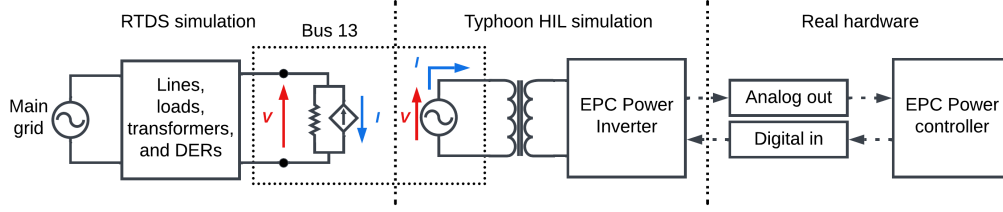

Figure 4: Simplified circuit diagram for the integrated real-time simulation. The UCSD microgrid model is decoupled at bus 13 and the two sub-circuits are separately simulated in the RTDS and Typhoon HIL. Voltage and current at bus 13 are synchronized between both simulators for consistent operation.

3.1 Voltage Regulation

The voltage regulation problem is an optimal power flow problem that is subject to maintaining voltages within specified limits. We employ the DERConnect testbed to model the voltage regulation scenario of the UCSD microgrid, illustrated in Figure 1. This microgrid operates as a distribution system, with a radial structure and no instances of islanding, as detailed in [24]. We test a novel algorithm developed in [24], which has been tailored to assumptions which are consistent with the UCSD microgrid. The voltage regulation problem for a network like this under a set of assumptions mentioned in [24] can be formulated as a second-order conic programming relaxation of the original nonlinear nonconvex voltage regulation problem, where the objective is to minimize the dissipated heat loss in each of the branches. The constraints model the physics of power flow in the network. Constraint (1b) ensures that voltage drops proportionally to the power flow in each branch. Constraints (1c) enforce apparent power balance at each node, respectively. Additionally, the network safety constraints on voltage and injected power are modeled in (1d) and (1e). Finally, (1f) ensures the relationship between voltage, current, and power. The formulation is as follows:

$$\begin{aligned}
 \min \quad & \sum_{\{i,j\} \in \mathcal{K}} J_{ij} \text{Re}(z_{ij}) & (1a) \\
 \text{s.t.} \quad & U_j = U_i + (r_{ij}^2 + x_{ij}^2)J_{ij} - 2(r_{ij}P_{ij} + x_{ij}Q_{ij}), & \forall \{i, j\} \in \mathcal{K} & (1b) \\
 & s_i^g - s_i^d = \sum_{j:i \rightarrow j} S_{ij} - \sum_{j:j \rightarrow i} (S_{ji} - z_{ji}J_{ji}) & \forall i \in \mathcal{N} & (1c) \\
 & s_i^{\max} \leq s_i^g \leq s_i^{\min}, & \forall i \in \mathcal{N} & (1d) \\
 & (V_i^{\max})^2 \leq U_i \leq (V_i^{\min})^2, & \forall i \in \mathcal{N} & (1e) \\
 & |S_{ij}|^2 \leq U_i J_{ij}, & \forall \{i, j\} \in \mathcal{K}. & (1f)
 \end{aligned}$$

where J_{ij}, U_j are the squared magnitude of the current in line (i, j) and voltage at node j respectively. The variables r_{ij} , and x_{ij} are the resistance and reactance in the line. The real and reactive power flowing in the line are P_{ij} and Q_{ij} , respectively. Shunt admittances from a node j to ground are modeled by g_j and b_j as the conductance and susceptance. Nodal power injection is modeled as the aggregation of generation p_j^g, q_j^g and load demanded p_j^d, q_j^d . Real and reactive generation at each node j is bounded above and below $p_j^{\max}, p_j^{\min}, q_j^{\max}, q_j^{\min}$. Voltage safety limits V_i^{\max}, V_i^{\min} are enforced for each node i .

In addition, we validate the distributed version of the program (1). The distributed version, also shown to converge in [24], separates the network into groups as shown in Figure 1. To collectively solve the problem, each group computes the solution to a reduced version of the problem (1). The reduced version only contains the subgraph of nodes in the group as well as nodes immediately adjacent. Separate instances of shared variables are held by each group, allowing parallel computation. Then, any parameters which

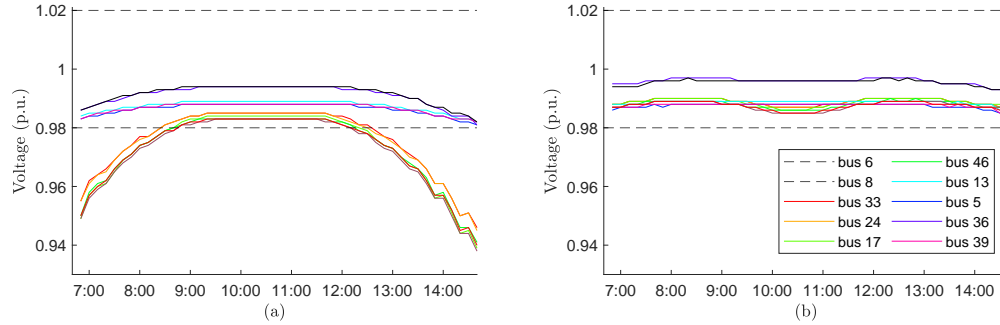

Figure 5: Artificial test case to check the effectiveness of the voltage regulation at select buses. a) without the voltage regulation and b) with the application of the voltage regulation.

belong to more than one group are shared between neighboring groups, allowing convergence to the optimal solution. We refer the reader to [24] for additional details.

3.2 Setup

We test several scenarios to investigate the performance of the proposed voltage regulation responses to variations in load and generation profiles from distributed renewable energy resources. The reduced model of the UCSD microgrid consists of 48 buses connected in a radial configuration. One bus, indexed 0, simulates the point of connection with the transmission system and has a nominal line-to-line voltage of 69 kV. The other 47 buses are separated by transformers as shown in Figure 1, with a nominal line-to-line voltage of 12.47 kV. Six simulated batteries are placed at nodes 13, 15, 23, 37, 45, 47. Each battery is assumed to be capable of providing 20 kVA. The lines in the network have resistance and reactance as given in [24]. We set the desired voltage regulation limit to $\pm 2\%$ of the nominal bus voltages.

We implement the testcase on the DERConnect platform with both centralized and distributed control. In the centralized case, we only require one DER node to send information to each of the distributed generation units. In the distributed control case, six DER nodes are used to implement the communication topology of the six groups as shown in Figure 1. We utilize two real-time simulation platforms—namely, the RTDS and Typhoon HIL simulators—alongside an EPC Power inverter controller, building load meters, and DER nodes. In the integrated real-time simulation, the RTDS simulator primarily replicates the UCSD microgrid network model, while the Typhoon HIL simulator emulates an inverter model controlled by the EPC Power inverter controller. Building load meters provide real-time measurements of energy consumption from university buildings, which we then integrate into load components that are simulated in the RTDS simulator. The DER nodes, serving as digital controllers, facilitate the implementation of control algorithms. Our voltage regulation algorithm was implemented and tested with these controllers, assigned to both simulated DERs in the RTDS and the EPC Power inverter controller. The entire simulation is comprehensively monitored and visualized through the DERMS platform.

We start by simulating the centralized voltage regulation as formulated in (1). The setup is shown in Figure 2. The single DER-node used from the DERConnect testbed in the centralized operation is an Axiomtek IoT edge controller Intel Core i7-1265UE with 32GB of RAM. We also implemented the distributed version of the voltage regulation described in (1). To apply the distributed algorithm, we split the UCSD microgrid into 6 groups as shown in Figure 1. Each group calculates power setpoints for the battery that is contained in the group’s subset of nodes. Both algorithms are configured to activate when significant variations exist between a new load readout and the load data employed in the current solution.

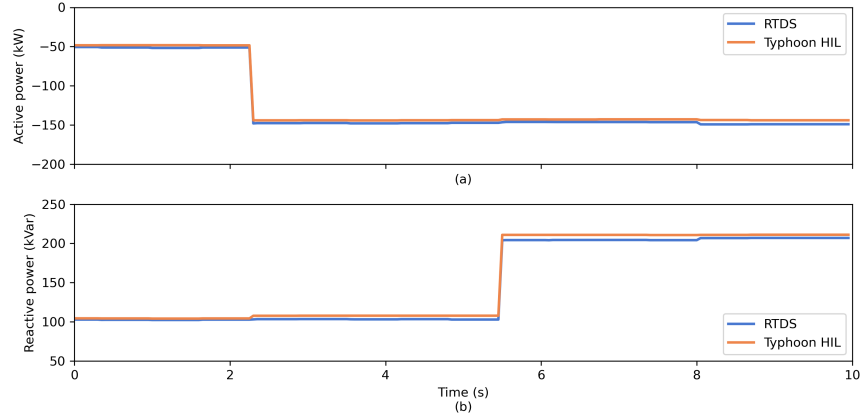

Figure 6: Artificial test case to check for RTDS and Typhoon HIL consistency. (a) Active power and (b) reactive power measurements at bus 13 in the RTDS and Typhoon HIL. The EPC Power inverter is operated to inject 100 kW of the active power and 100 kVar of the reactive power at 0 s. The active power setpoint changes to 200 kW at 2.3 s and the reactive power setpoint changes to 200 kVar at 5.5 s.

All inverters and their controllers are simulated in RTDS, except the inverter connected to node 13, which is simulated in Typhoon HIL and controlled by the real commercial inverter controller manufactured by EPC Power Corporation. The distributed configuration is implemented on the DER nodes. Different DER-nodes were used to operate the batteries in each group shown in Figure 1. The DER-nodes used to operate groups 0, 1, and 2 are Axiomtek IoT edge controllers Intel Core i7-1265UE with 32GB. The DER-nodes used to operate groups 3, 4, and 5 are Axiomtek IoT edge controllers Intel Atom x6414RE with 32GB. Each distributed group's subproblem is implemented in Python using a CVXpy model [25, 26] and solved with the Mosek [27] solver.

To incorporate the response of the PV power plant into our simulation, we follow an approach similar to the method described in [28], where meteorological data are fed into a PV performance model to estimate the power output of the solar generator. The data inputs of global horizontal irradiation (GHI), direct normal irradiation (DNI), diffuse horizontal irradiation (DHI), wind speed, and temperature were obtained from historical data for the La Jolla, California area provided by The National Solar Radiation Data Base [29] for January 1, 2022. To evaluate the effectiveness of the algorithms, we perform simulations under a dynamic artificial inductive load scenario within the UCSD microgrid. Figure 5 presents a comparative analysis of voltages at specific buses under two conditions: a) without the voltage regulation and b) with the application of the voltage regulation. Notably, Figure 5.a highlights instances where the predefined voltage limit of $\pm 2\%$ is exceeded at multiple buses. In contrast, when employing the voltage regulation algorithm, shown in Figure 5.b, all voltages consistently adhere to this specified limit, thereby affirming the algorithm's effectiveness.

3.3 RTDS and Typhoon HIL Consistency Check

The active and reactive power responses of the EPC Power inverter, measured in both the RTDS and Typhoon HIL simulators, are compared to validate the integrity of the integrated real-time simulation, confirming its consistency in response to changes in setpoints. Figs. 6a and 6b show, respectively, the active and reactive power measurements that are obtained at bus 13 for 10 sec, where we changed both active power and reactive power setpoints asynchronously. Figure 6 shows that the power flows in the two simulators tend to be almost identical, however a small amount of errors always remains. These errors are likely caused by use of phasor quantities to integrate the two simulators while both simulators run the EMT simulation. Moreover, the reproduction process of the EPC inverter response in sinusoidal waveform in the RTDS based

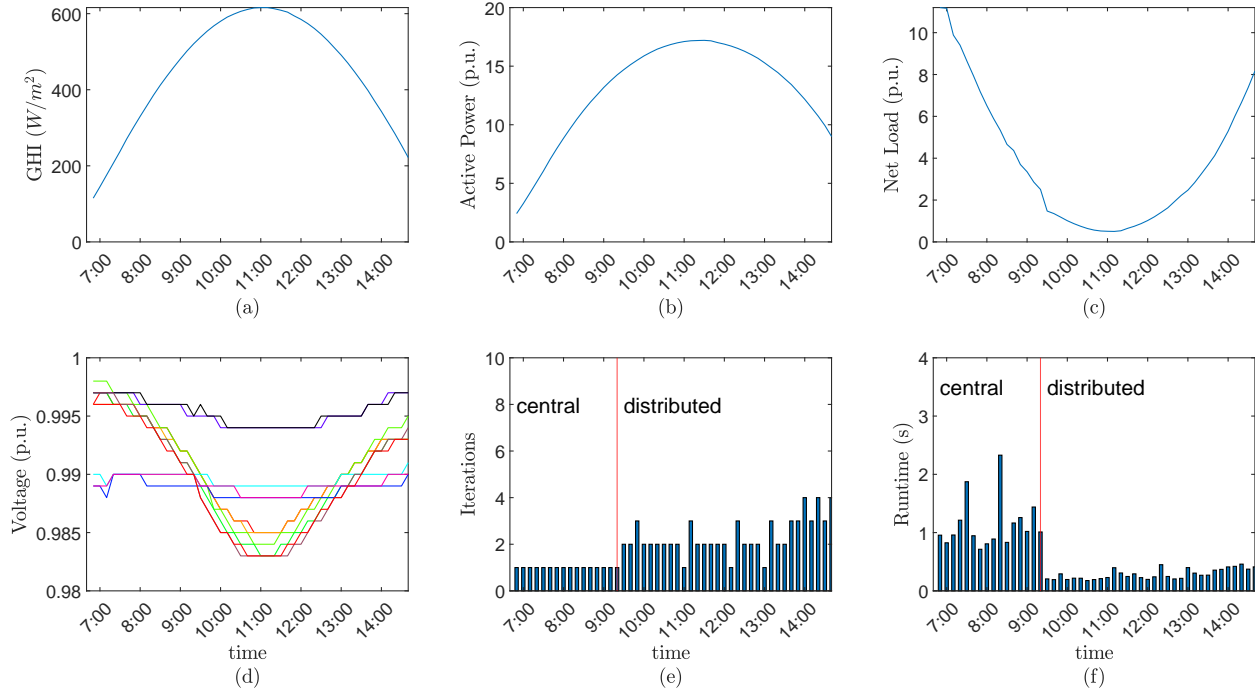

Figure 7: a) Daily profile of solar irradiance for the UCSD area on January 1, 2022 from the National Solar Radiation Database. b) Modeled solar power generation. c) Aggregated net load on the modeled microgrid. d) Voltage profile response for a select group of nodes in the modeled microgrid (bus 6 in red, bus 5 in pink, bus 8 in orange, bus 13 in purple, bus 17 in light blue, bus 24 in green, bus 33 in light green, bus 36 in black, bus 39 in brown, and bus 46 in blue). e) Number of iterations and f) runtime required for convergence of the voltage regulation algorithm. Regulation signals for the first 15 time steps until 0900 h are calculated by the centralized algorithm, afterward setpoints are calculated by the distributed version.

on the magnitude and angle sent from the Typhoon HIL can result in such small but stationary errors. Using analog cable connection to directly exchange the voltage and current waveform is expected to minimize the errors.

3.4 Case Study Results

This section shows the results of applying the voltage control problem to the simulation framework described. For this test, we validate the safety of the voltage profiles, whether the algorithm can be applied in real time, and that the algorithm can perform under variable loading. Figure 7a shows the irradiance in W/m^2 . These inputs are then fed into a model of the Canadian Solar CS5P-220M, a 220-watt solar panel, for irradiance-to-power conversion, and the overall PV system is rated at 22 MW. The aggregated generation of all PVs in the 36 buses is illustrated in Figure 7b, leveraging the pvlb software [30, 31]. Subtracting solar PV power injections from the building loads give the net loads that are input to each of the nodes in the network, the sum of which is shown in Figure 7c. The building loads are read at one second resolution.

This dynamic loading scenario validates that the algorithms can perform under realistic loading conditions. At each time step, the voltage control algorithm calculates battery power injections to regulate the voltage that results from the net load imposed by both load and solar generation. In the centralized scenario, setpoints are recalculated at every time step, whereas the distributed approach uses a warm-start provided by the

previous time step's solution, resulting in faster and harmonised setpoint convergence. Figure 7e shows the number of iterations the distributed algorithm took to converge as the net load fluctuated. In 7e, the centralized algorithm consistently converges after only 1 iteration. Figure 7f shows the runtime of both algorithms as the net load fluctuates. The centralized algorithm converges after about 1 sec. The distributed algorithm converges faster averaging 0.3 sec. These fast convergence times validate one of the goals of simulation, that the algorithms could be used to calculate voltage regulation signals in real time with minimal lag time. Recall that only the distributed algorithm is warm-started by the previous solution. The voltage magnitude of a subset of buses corresponding to the net load is illustrated in Figure 7d. This, along with the before and after voltage profile comparison in Figure 5, validates the final point that voltage is safely regulated.

4 CONCLUSION

This paper presents a study on real-time hybrid co-simulation for voltage regulation within the UCSD microgrid, featuring high penetration of DERs. By integrating physical assets such as hardware inverter controllers and building meters with simultaneous and synchronized simulation of two subsystems in the RTDS and Typhoon HIL platforms, we established a framework replicating realistic operating conditions. We focused on voltage regulation using centralized and distributed algorithms, applying a second-order conic relaxation approach to enhance efficiency. The developed hybrid co-simulation framework, utilizing assets from the DERConnect testbed for testing distributed voltage regulation, demonstrates the method's effectiveness and suitability in real-world microgrid scenarios, especially considering its scalability advantage. The successful application of both algorithms in the reduced model of the UCSD microgrid showcases their adaptability. In addition, integrating real-time load metering data enriches the simulation, adding realism and practical relevance.

This research advances practical testing of voltage control strategies in microgrids. The scalability and adaptability of the proposed algorithms offer insights for enhancing the stability and efficiency of the power distribution system, particularly with DERs. As the energy landscape evolves, these findings pave the way for more robust and cost-effective testing of DERs, enabling confident deployment with practically tested solutions addressing deployment challenges. This work is a significant step forward, providing a foundation for further research and development in realistic microgrid control strategy testing.

REFERENCES

- [1] G. D. Office. (2023) Grid resilience and innovation partnerships program. [Online]. Available: <https://www.energy.gov/gdo/grid-resilience-and-innovation-partnerships-grip-program>
- [2] International Energy Agency, "World energy outlook 2023," Tech. Rep., 2023.
- [3] N. A. E. R. Corporation, "Distributed energy resources: Connection modeling and reliability considerations," Tech. Rep., 2017.
- [4] R. Tonkoski, D. Turcotte, and T. H. M. EL-Fouly, "Impact of high PV penetration on voltage profiles in residential neighborhoods," *IEEE Transactions on Sustainable Energy*, vol. 3, no. 3, pp. 518–527, 2012.
- [5] Y. Chen, Y. Shi, and B. Zhang, "Data-driven optimal voltage regulation using input convex neural networks," *Electric Power Systems Research*, vol. 189, p. 106741, 2020.
- [6] S.-E. Razavi, E. Rahimi, M. S. Javadi, A. E. Nezhad, M. Lotfi, M. Shafie-khah, and J. P. Catalão, "Impact of distributed generation on protection and voltage regulation of distribution systems: A review," *Renewable and Sustainable Energy Reviews*, vol. 105, pp. 157–167, 2019.
- [7] B. Zhang, A. Y. S. Lam, A. Domínguez-García, and D. Tse, "An optimal and distributed method for voltage regulation in power distribution systems," *IEEE Transactions on Power Systems*, vol. 30, no. 4, pp. 1714–1726, 2015.

- [8] Y. Zhang and J. Cortés, “Distributed transient frequency control for power networks with stability and performance guarantees,” *Automatica*, vol. 105, pp. 274–285, 2019.
- [9] X. Guillaud, M. O. Faruque, A. Tenenge, A. H. Hariri, L. Vanfretti, M. Paolone, V. Dinavahi, P. Mitra, G. Lauss, C. Dufour, P. Forsyth, A. K. Srivastava, K. Strunz, T. Strasser, and A. Davoudi, “Applications of real-time simulation technologies in power and energy systems,” *IEEE Power and Energy Technology Systems Journal*, vol. 2, no. 3, pp. 103–115, 2015.
- [10] S. R. Drauz, C. Spalthoff, M. Würtenberg, T. M. Kneikse, and M. Braun, “A modular approach for co-simulations of integrated multi-energy systems: Coupling multi-energy grids in existing environments of grid planning & operation tools,” in *2018 Workshop on Modeling and Simulation of Cyber-Physical Energy Systems (MSCPES)*, 2018, pp. 1–6.
- [11] G. Paludetto, E. Bionda, and F. Soldan, “MESP - an interoperable platform for multi-energy systems,” in *2022 AEIT International Annual Conference (AEIT)*, 2022, pp. 1–6.
- [12] M. Armendariz, M. Chenine, L. Nordström, and A. Al-Hammouri, “A co-simulation platform for medium/low voltage monitoring and control applications,” in *ISGT 2014*, 2014, pp. 1–5.
- [13] E. Widl, A. Sporr, M. Mairhofer, T. Natiesta, N. Marx, and R.-R. Schmidt, “Prototype of an open testbed for the lab validation of smart applications of district heating substations,” in *2022 10th Workshop on Modelling and Simulation of Cyber-Physical Energy Systems (MSCPES)*, 2022, pp. 1–6.
- [14] A. Erdmann, H. K. Çakmak, U. Kühnapfel, and V. Hagenmeyer, “A new communication concept for efficient configuration of energy systems integration co-simulation,” in *2019 IEEE/ACM 23rd International Symposium on Distributed Simulation and Real Time Applications (DS-RT)*, 2019, pp. 1–8.
- [15] Y. Li, L. M. Shi, H. Zhang, and Y. Du, “Real-time simulation of linear synchronous motor in hardware-in-loop test system,” in *2010 International Conference on Electrical Machines and Systems*, 2010, pp. 1520–1523.
- [16] Y. Li, D. Vilathgamuwa, and P. C. Loh, “Design, analysis, and real-time testing of a controller for multibus microgrid system,” *IEEE Transactions on Power Electronics*, vol. 19, no. 5, pp. 1195–1204, 2004.
- [17] Real-Time Simulation with the RTDS Simulator. [Online]. Available: <https://www.rtds.com/>
- [18] J. Langston, K. Schoder, M. Steurer, O. Faruque, J. Hauer, F. Bogdan, R. Bravo, B. Mather, and F. Katiraei, “Power hardware-in-the-loop testing of a 500 kw photovoltaic array inverter,” in *IECON 2012 - 38th Annual Conference on IEEE Industrial Electronics Society*, 2012, pp. 4797–4802.
- [19] Typhoon HIL - Expert Hardware-in-the-Loop Solutions. [Online]. Available: <https://www.typhoon-hil.com/>
- [20] C. S. Goli, M. Manjrekar, P. Sahu, A. Chanda, and S. Essakiappan, “Implementation of stationary and synchronous frame current regulators for grid tied inverter using typhoon hardware in loop system,” in *2021 IEEE 12th International Symposium on Power Electronics for Distributed Generation Systems (PEDG)*, 2021, pp. 1–8.
- [21] R. S. P.C. Pradhan and S. Panda, “Analysis of hybrid fuzzy logic control based pid through the filter for frequency regulation of electrical power system with real-time simulation,” *Journal of Control, Automation and Electrical Systems*, no. 32, p. 439–457, 2021.
- [22] [Online]. Available: <https://sites.google.com/ucsd.edu/derconnect/>
- [23] J. Kleissl, A. Khurram, K. Chia, S. Brown, A. Mishra, J. Cortes, R. de Callafon, R. Gupta, S. Martinez, and D. Victor, “Derconnect: a distributed energy resources testbed for solar power integration,” in *Proceedings of the Thirteenth ACM International Conference on Future Energy Systems*, ser. e-Energy '22. New York, NY, USA: Association for Computing Machinery, 2022, p. 587–589. [Online]. Available: <https://doi.org/10.1145/3538637.3539633>
- [24] S. A. Sadat, B. Hwang, K. Murakami, and J. Cortes, “Realtime Distributed Voltage Regulation Using DERConnect Testbed: The UCSD Microgrid Case,” *Preprint*, 2024.

- [25] S. Diamond and S. Boyd, “CVXPY: A Python-embedded modeling language for convex optimization,” *Journal of Machine Learning Research*, vol. 17, no. 83, pp. 1–5, 2016.
- [26] A. Agrawal, R. Verschueren, S. Diamond, and S. Boyd, “A rewriting system for convex optimization problems,” *Journal of Control and Decision*, vol. 5, no. 1, pp. 42–60, 2018.
- [27] M. ApS, *MOSEK Optimizer API for Python 9.3.22*, 2022. [Online]. Available: <https://docs.mosek.com/9.3/pythonapi/index.html>
- [28] W. Wang, Y. Guo, D. Yang, and J. Kleissl, “Solar power forecasting based on numerical weather prediction and physical model chain for day-ahead power system dispatching,” in *2022 4th International Conference on Smart Power and Internet Energy Systems (SPIES)*, 2022, pp. 2081–2086.
- [29] M. Sengupta, Y. Xie, A. Lopez, A. Habte, G. Maclaurin, and J. Shelby, “The national solar radiation data base (nsrdb),” *Renewable and Sustainable Energy Reviews*, vol. 89, pp. 51–60, 2018.
- [30] W. Holmgren, K. Anderson, C. Hansen, rob andrews, M. Mikofski, A. R. Jensen, A. Lorenzo, U. Krien, bmu, A. Driesse, C. Stark, DaCoEx, M. S. de León Peque, T. Transue, E. Luis, kt, N. Priyadarshi, mayudong, Heliolytics, E. Miller, M. A. Anoma, V. Guo, L. Boeman, J. Stein, S. Aneja, W. Vining, jforbess, T. Lunel, C. Leroy, and A. Morgan, “pvlb/pvlb-python: v0.10.3,” Dec. 2023. [Online]. Available: <https://doi.org/10.5281/zenodo.10412885>
- [31] W. F. Holmgren, C. W. Hansen, and M. A. Mikofski, “pvlb python: a python package for modeling solar energy systems,” *Journal of Open Source Software*, vol. 3, no. 29, p. 884, 2018. [Online]. Available: <https://doi.org/10.21105/joss.00884>

SAYED ABDULLAH SADAT is a postdoctoral scholar in the Department of Mechanical and Aerospace Engineering at UC San Diego. Sadat’s research interests lie at the intersection of power markets, transmission systems operation and planning, active distribution networks, optimization, high-performance computing, and artificial intelligence. His email address is email@sayedsadat.com.

BENJAMIN HWANG is a Ph.D. student in the Department of Mechanical and Aerospace Engineering at UC San Diego. His research interests include optimization and control of networked systems. His email address is bdhwang@ucsd.edu.

KOHEI MURAKAMI is a postdoctoral scholar in the Department of Mechanical and Aerospace Engineering at UC San Diego. Murakami’s research interests are power system control and optimization, microgrid control, power electronics control, and cybersecurity of power systems. His email address is k1murakami@ucsd.edu.

JAN KLEISSL is the Director of the Center for Energy Research and the NSF DERConnect Research Facility at UC San Diego. Kleissl’s research interests are optimization of distributed energy resources under high solar penetration. His email address is jkleissl@ucsd.edu.

JORGE CORTES (M’02, SM’06, F’14) is a Professor in the Department of Mechanical and Aerospace Engineering at UC San Diego, holding the Cymer Corporation Endowed Chair in High Performance Dynamic Systems Modeling and Control. He is a Fellow of IEEE, SIAM, and IFAC. His research interests include distributed control and optimization, network science, nonsmooth analysis, reasoning and decision making under uncertainty, network neuroscience, and multi-agent coordination in robotic, power, and transportation networks. His email address is cortes@ucsd.edu.

ADIL KHURRAM is a scientist working under the supervision of Prof. Jan Kleissl on the NSF funded project DERConnect at the University of California, San Diego. His research interests include optimization and control of distributed energy resources, statistical electrical load modeling, and forecasting of renewable energy resources. His email address is akhurram@ucsd.edu.